

Layout top view

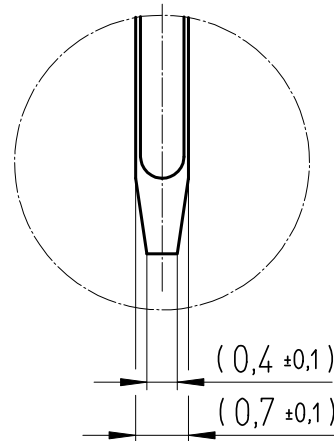

Tab material: Stainless steel

All framed values will be used for dimension checking !

The Products of Renata SA are neither designed nor authorized for use in certain areas of application of environment. For further details we refer to our webpage: www.renata.com/downloads/restriction_of_use

Rev.	①	12.09.2019	SRi	Rev.	⊙	.	.		Customer's Approval		
Rev.	⊙	.	.	Rev.	⊙	.	.		Date		
Rev.	⊙	.	.	Rev.	⊙	.	.		Signature		
Titel:								Scale 2:1	Drawn	22.12.04	SRi
CR1225FV-LF									Checked	13.09.19	HSn
									Approved	16.09.19	MDi
				CH-4452 Itingen Switzerland				3.8703.4-1			

- Samples can deviate in the execution from the serie.

- Dimensions and tolerances can be specified only after the testing of the devices for the mass production definitely